



ProLight PBVJ-10FWE-F3GR1
10W Power LED
Technical Datasheet
Version: 1.1

ProLight Opto ProEngine Series

Features

- High flux density of lighting source
- Good color uniformity
- RoHS compliant
- More energy efficient than incandescent and most halogen lamps
- Long lifetime
- AEC-Q102 compliant
- SAE/ECE compliant

Main Applications

- Bicycle Lamps
- Exterior Automotive Lighting
- Floodlight
- Bending Light
- Daytime Running Light

Introduction

- The input power is 10 Watt, the multi-chip ultra high power ProEngine Series delivers never before seen luminous flux output from a single emitter. The superficial illuminating nature of ProEngine makes them the preference bicycle lamps, typical applications include exterior automotive lighting Bending and Daytime Running Light.

Emitter Mechanical Dimensions

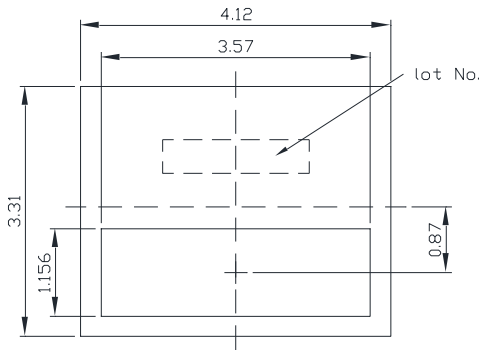

Top View

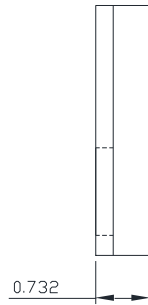

Side View

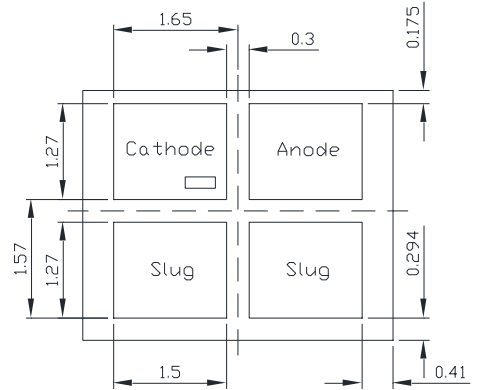

Bottom View

Circuit Diagram

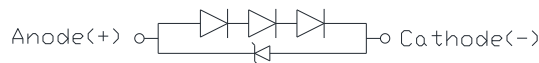

Notes:

1. Solder pads are labeled "+" and "-" to denote positive and negative, respectively.
2. Drawing not to scale.
3. All dimensions are in millimeters.
4. Unless otherwise indicated, tolerances are ± 0.1 mm.
5. **Please do not use a force of over 0.3kgf impact or pressure on the lens of the LED, otherwise it will cause a catastrophic failure.**

*The appearance and specifications of the product may be modified for improvement without notice.

Flux Characteristics, $T_j = 25^\circ\text{C}$

Radiation Pattern	Color	Part Number Emitter	Luminous Flux Φ_v (lm)			
			@1000mA		Refer @1200mA	
			Min.	Typ.	Min.	Typ.
Flat	White	PBVJ-10FWE-F3GR1	1060	1170	1270	1340

- ProLight maintains a tolerance of $\pm 7\%$ on flux and power measurements.
- Please do not drive at rated current more than 1 second without proper heat sink.

Electrical Characteristics, $T_j = 25^\circ\text{C}$

Color	Forward Voltage V_F (V)				Thermal Resistance Junction to Slug ($^\circ\text{C}/\text{W}$)
	Min.	@1000mA Typ.	Max.	Refer @1200mA Typ.	
White	7.2	9.7	11.5	9.9	2.7

- ProLight maintains a tolerance of $\pm 0.1\text{V}$ for Voltage measurements.

Optical Characteristics at 1000mA, $T_j = 25^\circ\text{C}$

Radiation Pattern	Color	Color Temperature CCT			Total included Angle (degrees)	Viewing Angle (degrees)
		Min.	Typ.	Max.	$\theta_{0.90v}$	$2\theta_{1/2}$
Flat	White	5380 K	5620 K	5860 K	160	120
		5620 K	5880 K	6140 K	160	120
		5870 K	6150 K	6430 K	160	120
		6140 K	6450 K	6760 K	160	120

- ProLight maintains a tolerance of $\pm 5\%$ for CCT measurements.

Absolute Maximum Ratings

Parameter	White
Max DC Forward Current (mA)	1500
Peak Pulsed Forward Current (mA)	1500 (less than 1/10 duty cycle@1KHz)
LED Junction Temperature	150°C
Junction Temperature for short time applications*	175°C
Operating Board Temperature at Maximum DC Forward Current	-40°C - 125°C
Storage Temperature	-40°C - 125°C
Reverse Voltage	Not designed to be driven in reverse bias
ESD withstand voltage(kV) acc. to ANSI/ESDA/JEDEC JS-001 (HBM, Class 3B)	up to 8

Note: * The LED chip exhibits excellent performance but slight package discoloration occurs at highest temperatures. Exemplary median lifetime for $T_J = 175^\circ\text{C}$ is 100h.

Photometric Luminous Flux Bin Structure

Color	Bin Code	Minimum Photometric Flux (lm)	Maximum Photometric Flux (lm)	Available Color Bins
White	T2	1060	1100	All
	T3	1100	1140	All
	T4	1140	1185	All
	T5	1185	1230	All
	T6	1230	1275	[1]
	T7	1275	1325	[1]
	T8	1325	1375	[1]
	T9	1375	1425	[1]

- ProLight maintains a tolerance of $\pm 7\%$ on flux and power measurements.
- The flux bin of the product may be modified for improvement without notice.
- ^[1] The rest of color bins are not 100% ready for order currently. Please ask for quote and order Possibility.

Color Bin

White Binning Structure Graphical Representation

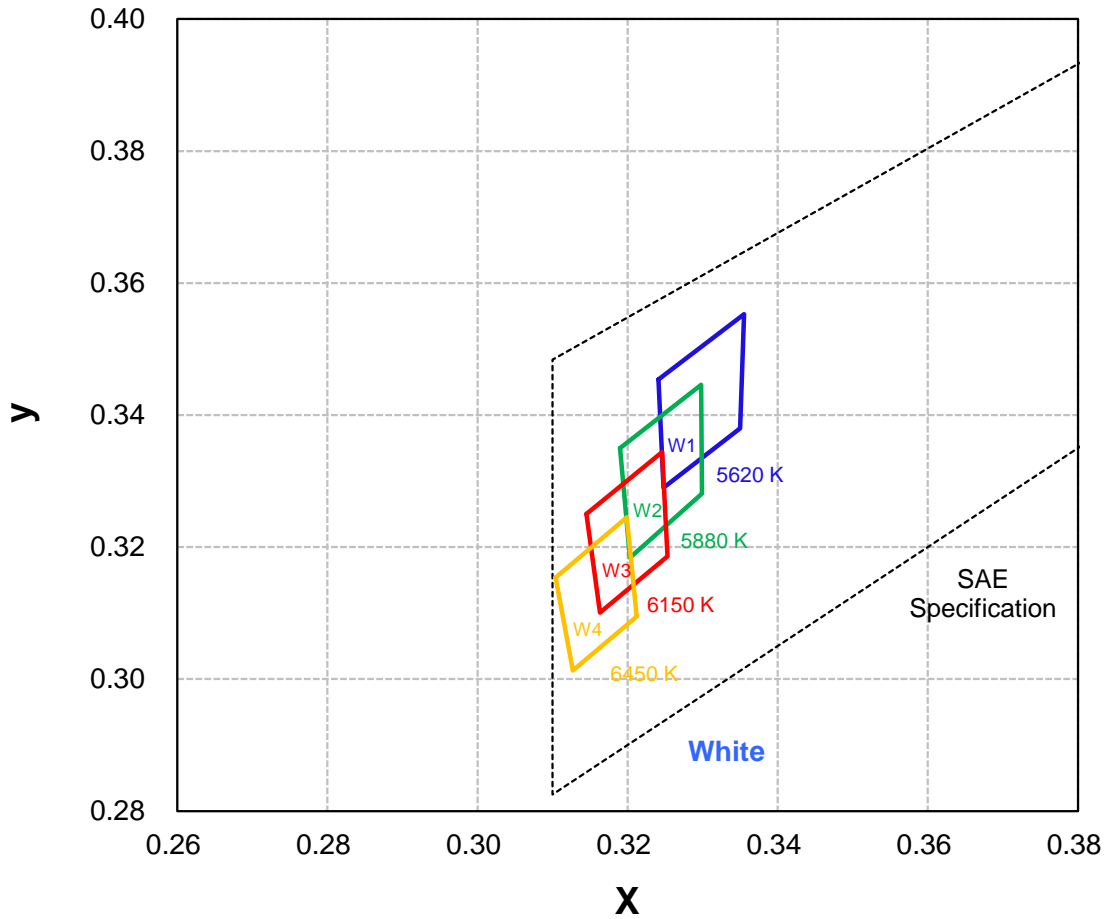

White Bin Structure

Bin Code	x	y	Typ. CCT (K)	Bin Code	x	y	Typ. CCT (K)
W1	0.3241	0.3454	5620	W3	0.3145	0.3250	6150
	0.3248	0.3290			0.3163	0.3101	
	0.3350	0.3380			0.3253	0.3186	
	0.3355	0.3553			0.3246	0.3344	
W2	0.3190	0.3350	5880	W4	0.3104	0.3154	6450
	0.3203	0.3184			0.3127	0.3013	
	0.3299	0.3281			0.3212	0.3095	
	0.3298	0.3446			0.3199	0.3245	

- Tolerance on each color bin (x , y) is ± 0.005

Color Spectrum, $T_j = 25^\circ\text{C}$

1. White

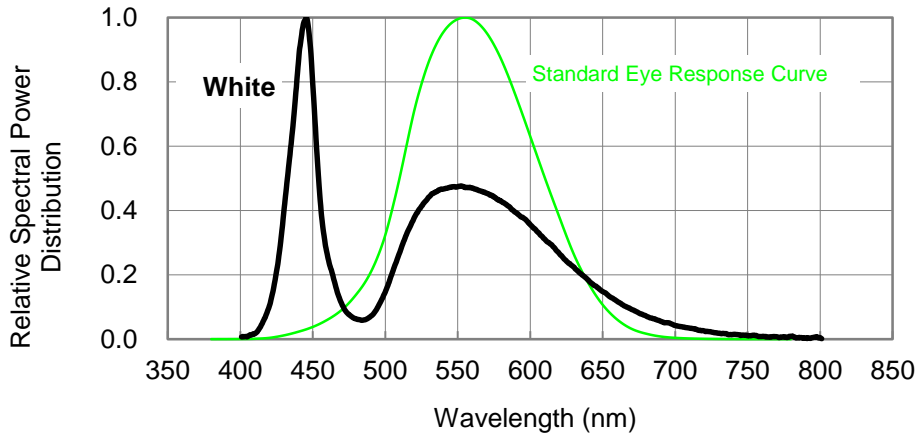

Junction Temperature Relative Characteristics

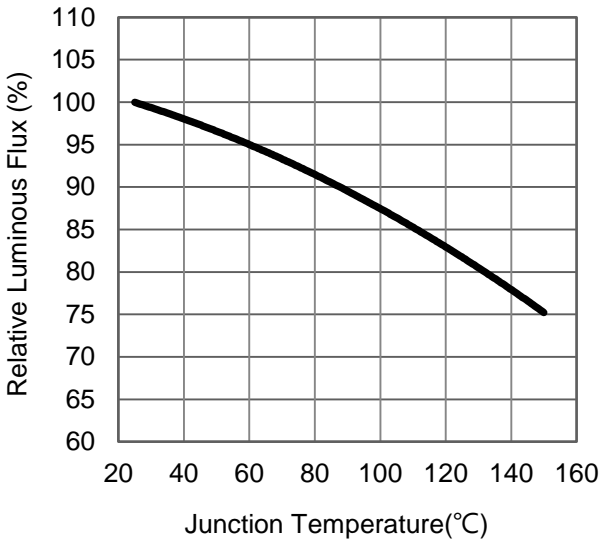

Fig 1. Junction Temperature vs. Relative Luminous Flux at 1000mA.

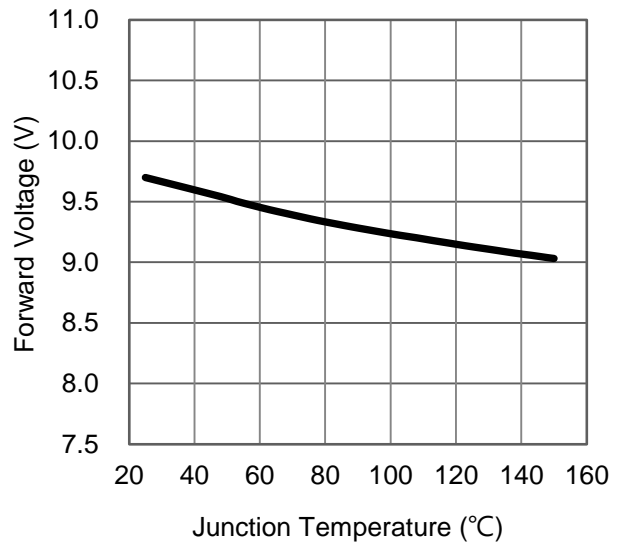

Fig 2. Junction Temperature vs. Forward Voltage at 1000mA.

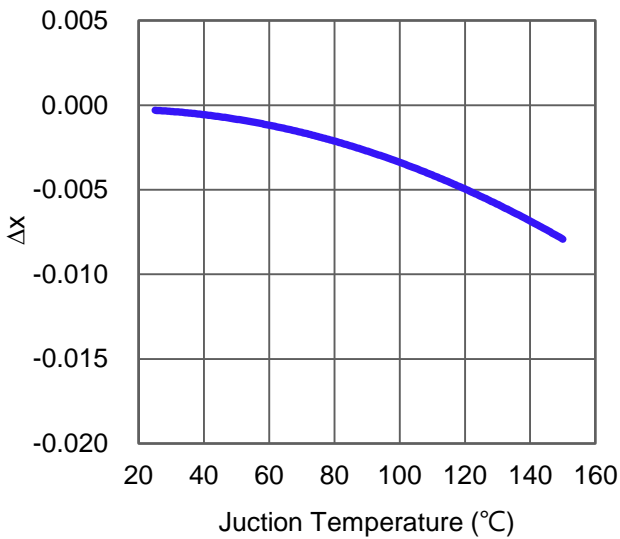

Fig 3. Junction Temperature vs. Chromaticity Coordinate Δx at 1000mA.

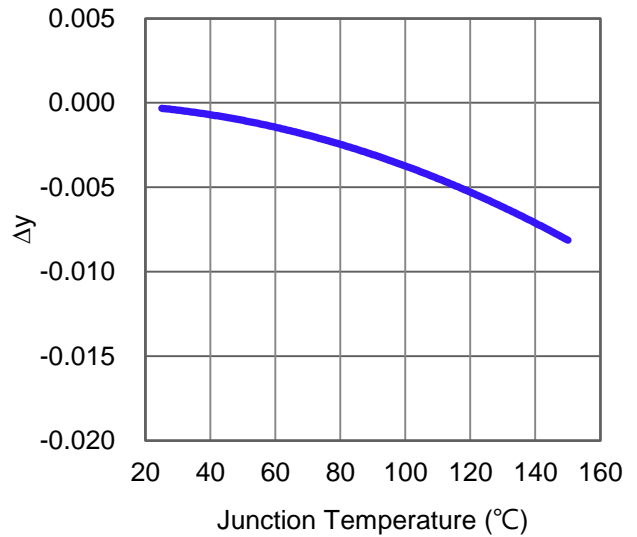

Fig 4. Junction Temperature vs. Chromaticity Coordinate Δy at 1000mA.

Forward Current Relative Characteristics

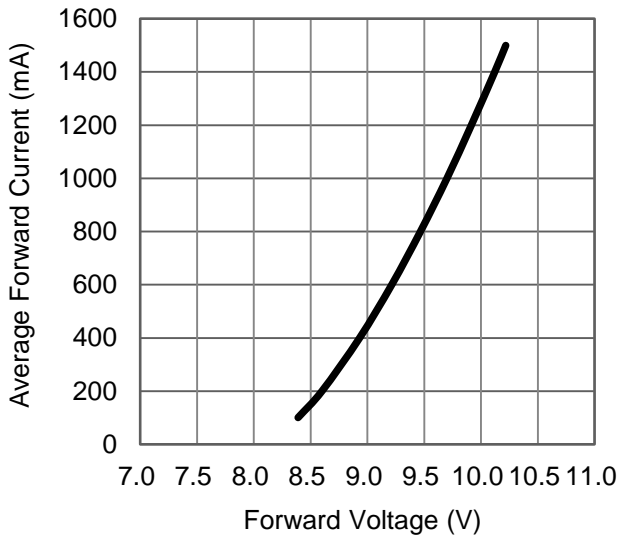

Fig 5. Forward Voltage vs. Forward Current at $T_J=25^{\circ}\text{C}$.

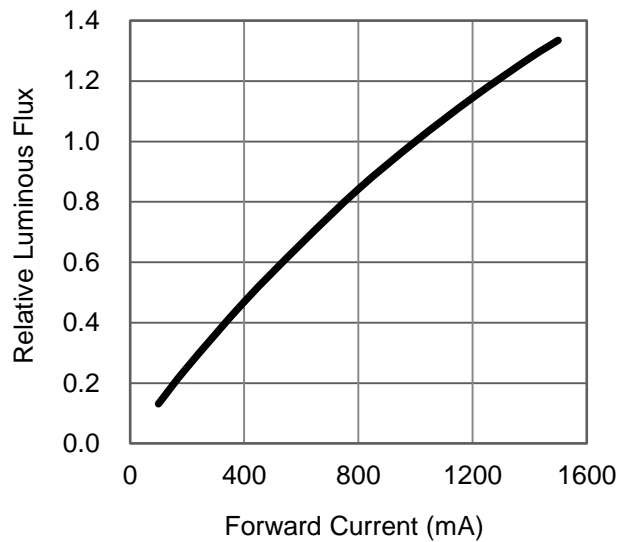

Fig 6. Forward Current vs. Relative Luminous Flux at $T_J=25^{\circ}\text{C}$.

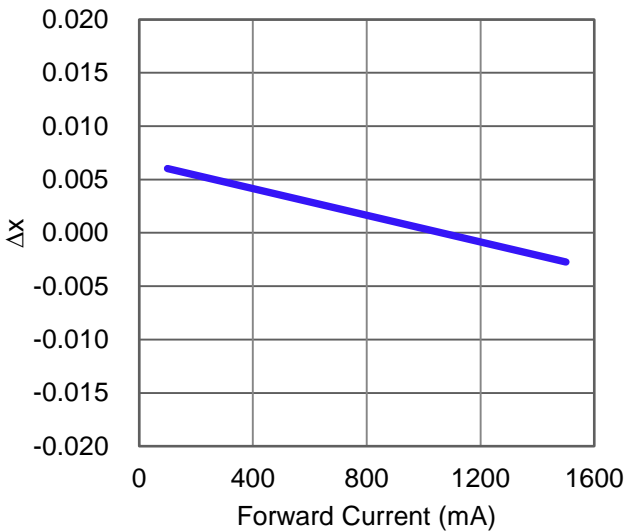

Fig 7. Forward Current vs. Chromaticity Coordinate Δx at $T_J=25^{\circ}\text{C}$.

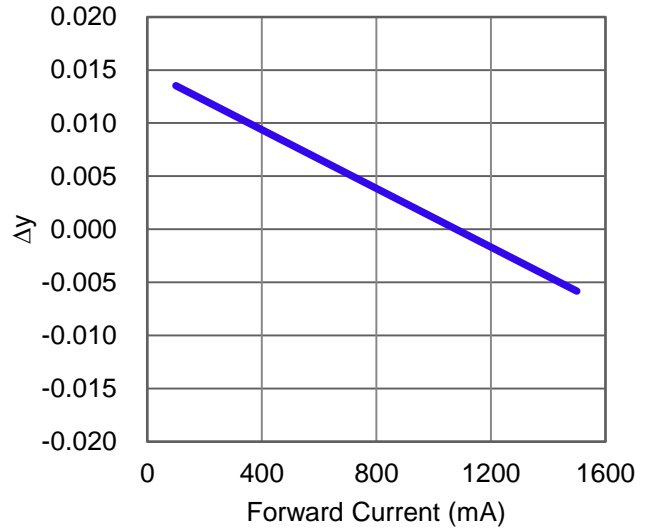
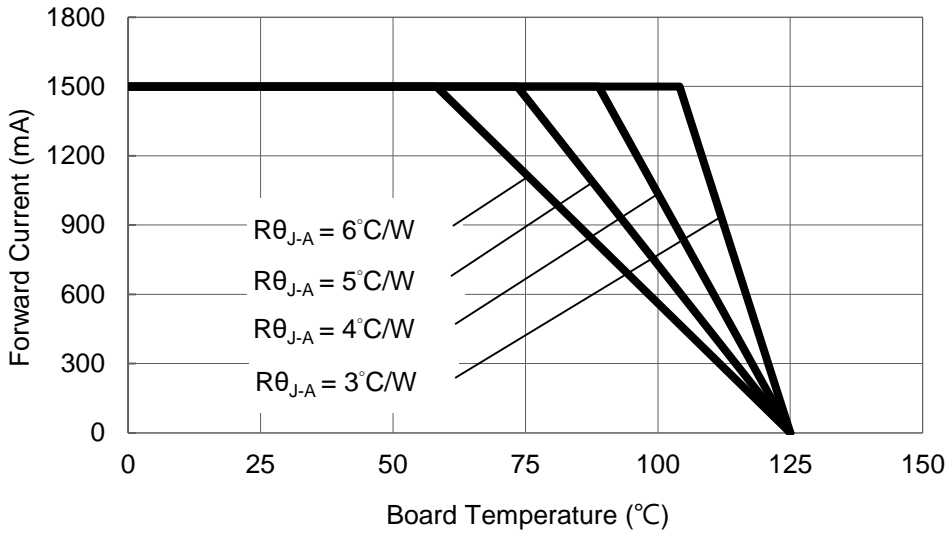

Fig 8. Forward Current vs. Chromaticity Coordinate Δy at $T_J=25^{\circ}\text{C}$.

Board Temperature vs. Maximum Forward Current

Maximum Forward Current



Typical Representative Spatial Radiation Pattern

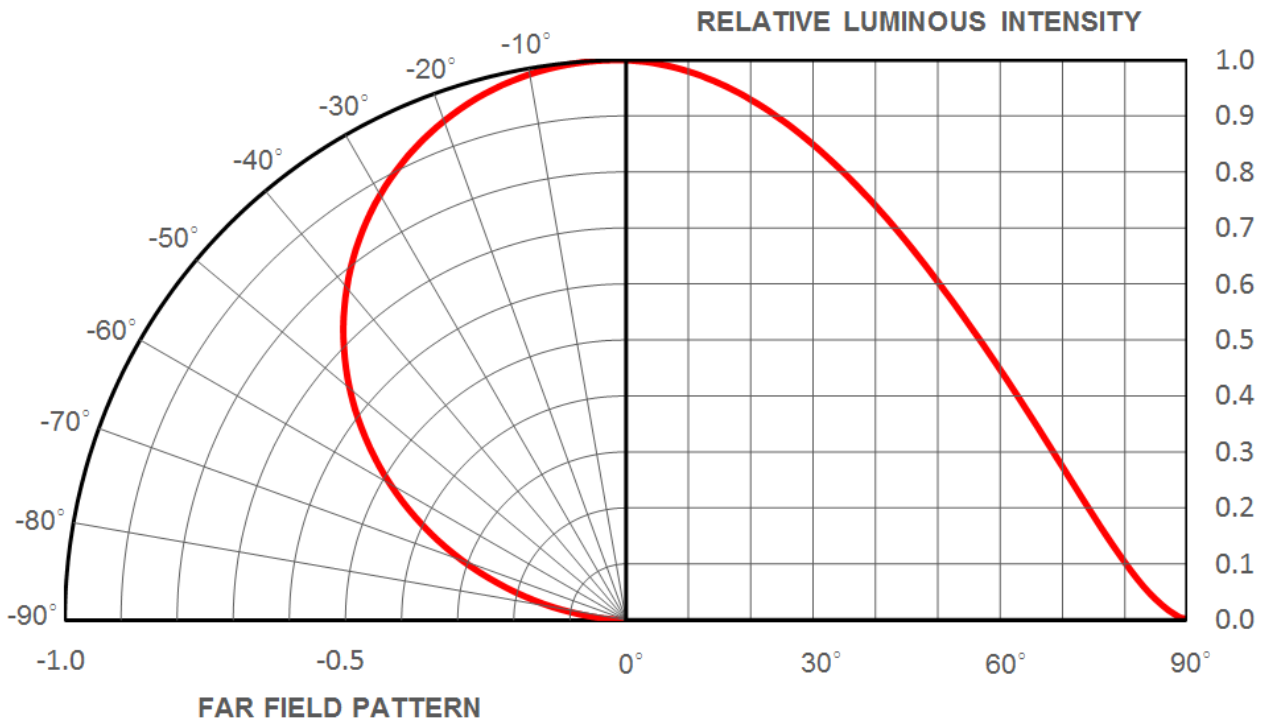

Moisture Sensitivity Level – JEDEC Level 1

Level	Floor Life		Soak Requirements			
			Standard		Accelerated Environment	
	Time	Conditions	Time (hours)	Conditions	Time (hours)	Conditions
1	Unlimited	≤30°C / 85% RH	168 +5/-0	85°C / 85% RH	NA	NA

- The standard soak time includes a default value of 24 hours for semiconductor manufacture's exposure time (MET) between bake and bag and includes the maximum time allowed out of the bag at the distributor's facility.
- Table below presents the moisture sensitivity level definitions per IPC/JEDEC's J-STD-020C.

Level	Floor Life		Soak Requirements			
			Standard		Accelerated Environment	
	Time	Conditions	Time (hours)	Conditions	Time (hours)	Conditions
1	Unlimited	≤30°C / 85% RH	168 +5/-0	85°C / 85% RH	NA	NA
2	1 year	≤30°C / 60% RH	168 +5/-0	85°C / 60% RH	NA	NA
2a	4 weeks	≤30°C / 60% RH	696 +5/-0	30°C / 60% RH	120 +1/-0	60°C / 60% RH
3	168 hours	≤30°C / 60% RH	192 +5/-0	30°C / 60% RH	40 +1/-0	60°C / 60% RH
4	72 hours	≤30°C / 60% RH	96 +2/-0	30°C / 60% RH	20 +0.5/-0	60°C / 60% RH
5	48 hours	≤30°C / 60% RH	72 +2/-0	30°C / 60% RH	15 +0.5/-0	60°C / 60% RH
5a	24 hours	≤30°C / 60% RH	48 +2/-0	30°C / 60% RH	10 +0.5/-0	60°C / 60% RH
6	Time on Label (TOL)	≤30°C / 60% RH	Time on Label (TOL)	30°C / 60% RH	NA	NA

Reliability testing in accordance with AEC-Q102

The development of this product included extensive operational life-time testing and environmental testing. Table 1 summarizes the tests applied and cumulative test results obtained from testing performed in accordance with AEC-Q102.

Table 1. Operating life, mechanical and environmental tests performed on it's package in accordance with AEC-Q102.

#	STRESS	ABV	Conditions	Duration	Failure Criteria	Rejects
<u>1</u>	Pre- and Post-Stress Electrical Test	TEST	Test is performed as specified in the applicable stress reference at room temperature.	N/A	See notes [2]	0
<u>A1</u>	Pre-conditioning	PC	Soak Tamb = 85 °C, RH = 85% Reflow soldering	N/A	See notes [2]	0
<u>A2a</u>	Wet High Temperature Operating Life	WHTOL 1	Tambient = 85 °C / 85% RH IF = max. DC [1]	1000 hours	See notes [2]	0
<u>A3a</u>	Power Temperature Cycling	PTC	-40°C to 85°C, 10 minutes dwell, 20 minutes transfer (1 hour cycle), 2 minutes ON/2 minutes OFF, IF = max. DC [1]	1000 hours	See notes [2]	0
<u>A4</u>	Temperature Cycling	TC	-40°C to 125°C, 15 minutes dwell	1000 cycles	See notes [2]	0
<u>B1a</u>	High Temperature Operating Life	HTOL1	Tsolder =85°C, IF = max. DC [1]	1000 hours	See notes [2]	0
<u>B1b</u>	High Temperature Operating Life	HTOL2	Maximum specified Tsolder, IF = max. DC [1]	1000 hours	See notes [2]	0
<u>C9</u>	Thermal Resistance	TR	All qualification parts submitted for testing	N/A	See notes [2]	0
<u>C10</u>	Solderability	SD	245 °C ± 5 °C	3s	See notes [3]	0
<u>C12</u>	Hydrogen Sulphide	H2S	Corrosion class A: (preferred) Duration 336 h at 40 °C and 90% RH. H2S concentration: 15ppm	336 hours	See notes [2]	0
<u>E3</u>	Electrostatic Discharge Human Body Model	HBM	ANSI/ESDA/JEDEC JS-001	N/A	See notes [3]	0
<u>G2</u>	Vibration Variable Frequency	VVF	10-2000-10 Hz, log or linear sweep rate, 20 G about 1 min., 1.5 mm, 3X/axis	N/A	See notes [3]	0
<u>G3</u>	Mechanical Shock	MS	1500 G, 0.5 msec. pulse, 5 shocks each 6 axis	N/A	See notes [3]	0

Notes:

- Depending on the maximum derating curve.
- Criteria for judging failure

Item	Test Condition	Criteria for Judgement	
		Min.	Max.
Forward Voltage (V_F)	$I_F = \text{max DC}$	--	Initial Level x 1.1
Luminous Flux or Radiometric Power (Φ_V)	$I_F = \text{max DC}$	Initial Level x 0.8	--
Reverse Current (I_R)	$V_R = 5V$	--	50 μA

* The test is performed after the LED is cooled down to the room temperature.

- A failure is an LED that is open or shorted.

Recommended Solder Pad Design

Standard Emitter

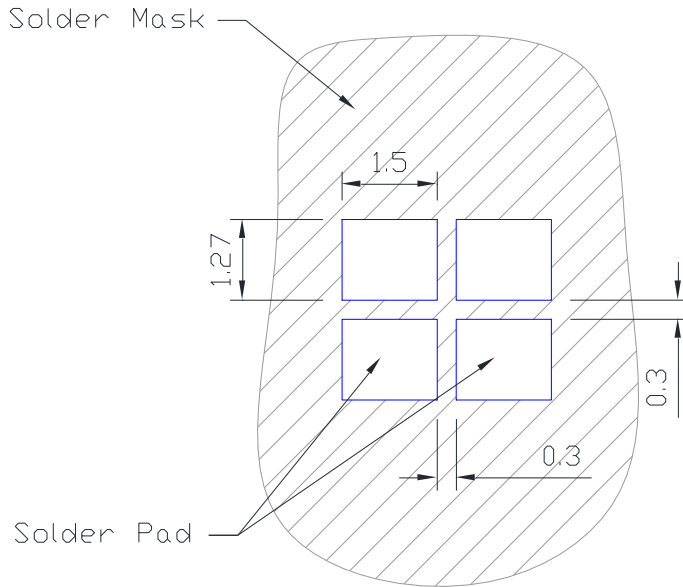

- All dimensions are in millimeters.

Recommended MCPCB Design

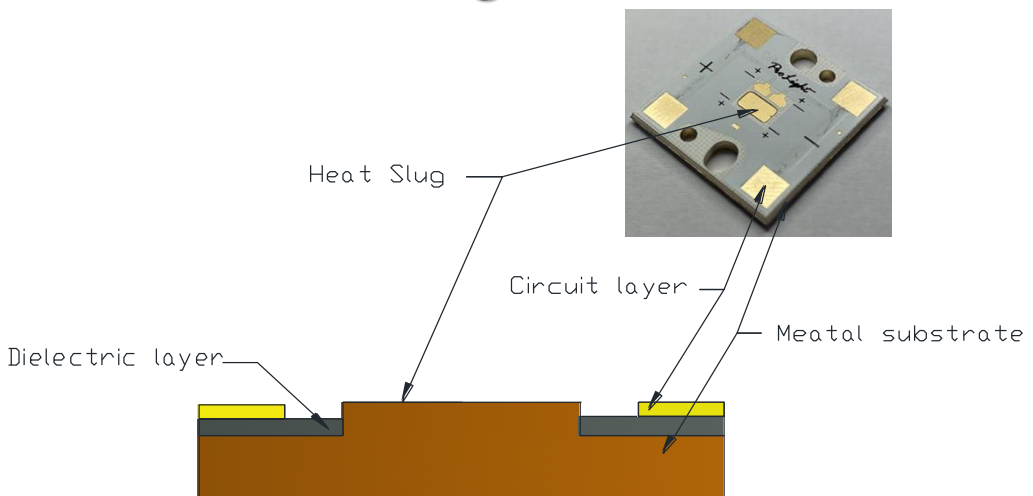

- Copper(Cu) substrate is recommended.
- The thermal conductivity of dielectric layer in the Aluminum(Al) substrate is greater or equal than 6w/mk.
- If the thermal conductivity of dielectric layer equal to 2w/mk, the power consumption should be lower than 20w.

Recommended Suction Nozzle Design

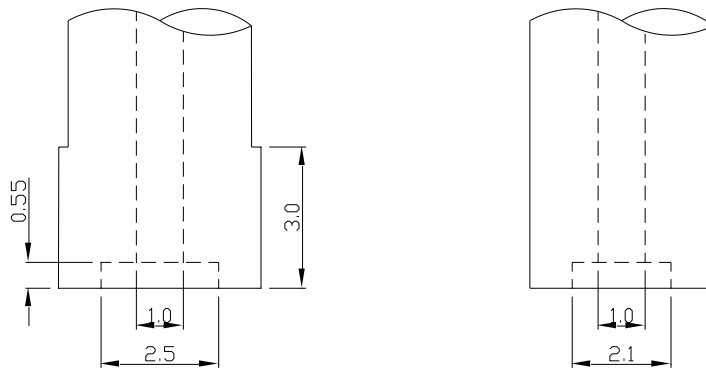

Side View

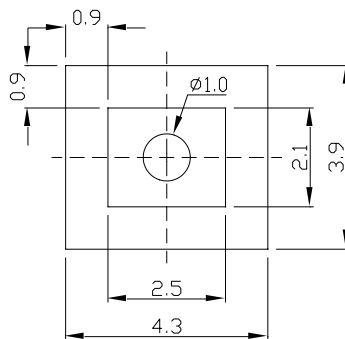

Bottom View

Notes:

1. All dimensions are in millimeters and tolerances are $\pm 0.05\text{mm}$.
2. Recommended the material of suction nozzle was PEEK.
3. The actual suction nozzle like below picture.



Reflow Soldering Condition

Profile Feature	Sn-Pb Eutectic Assembly	Pb-Free Assembly
Average Ramp-Up Rate (T_{Smax} to T_P)	3°C / second max.	3°C / second max.
Preheat		
– Temperature Min (T_{Smin})	100°C	150°C
– Temperature Max (T_{Smax})	150°C	200°C
– Time (t_{Smin} to t_{Smax})	60-120 seconds	60-180 seconds
Time maintained above:		
– Temperature (T_L)	183°C	217°C
– Time (t_l)	60-150 seconds	60-150 seconds
Peak/Classification Temperature (T_p)	240°C	260°C
Time Within 5°C of Actual Peak Temperature (t_p)	10-30 seconds	20-40 seconds
Ramp-Down Rate	6°C/second max.	6°C/second max.
Time 25°C to Peak Temperature	6 minutes max.	8 minutes max.

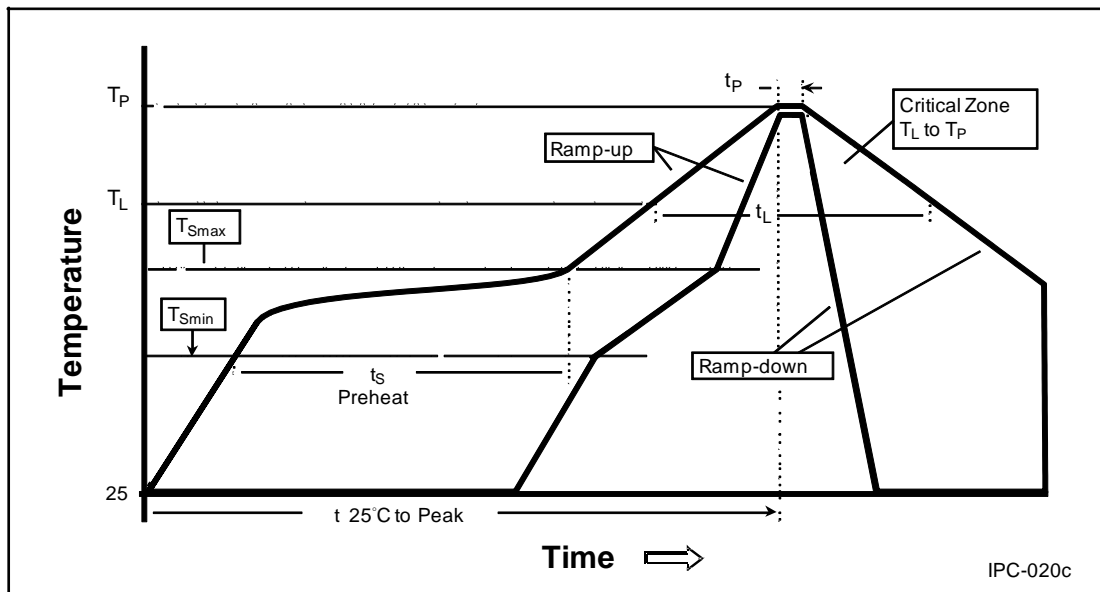

- We recommend using the M705-S101-S4 solder paste from SMIC (Senju Metal Industry Co., Ltd.) for lead-free soldering.
- Do not use solder pastes with post reflow flux residue > 47%. (58Bi-42Sn eutectic alloy, etc) This kind of solder pastes may cause a reliability problem to LED.
- All temperatures refer to topside of the package, measured on the package body surface.
- Repairing should not be done after the LEDs have been soldered. When repairing is unavoidable, a double-head soldering iron should be used. It should be confirmed beforehand whether the characteristics of the LEDs will or will not be damaged by repairing.
- Reflow soldering should not be done more than three times.
- When soldering, do not put stress on the LEDs during heating.
- After soldering, do not warp the circuit board.

Emitter Reel Packaging

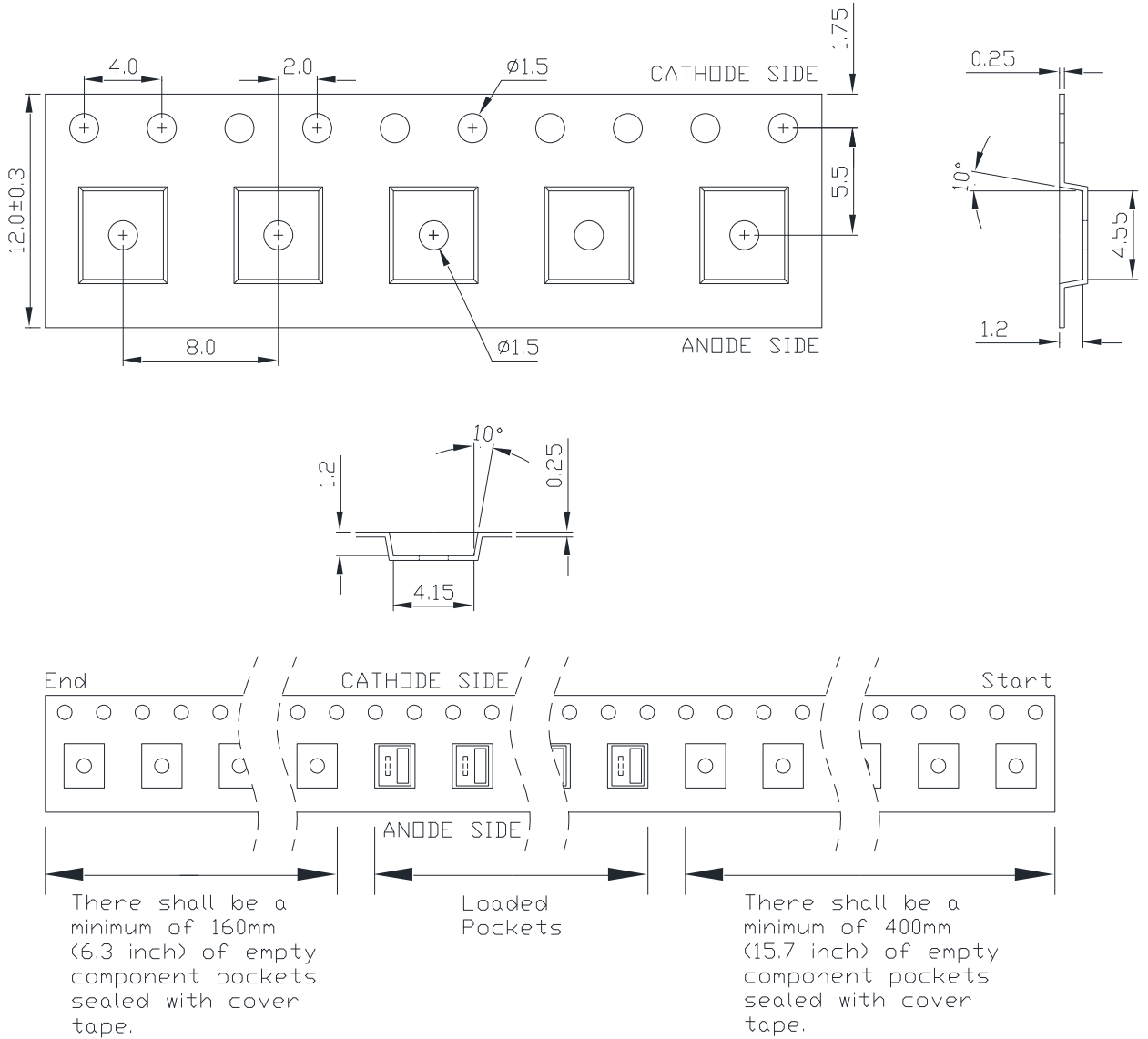

Notes:

1. Drawing not to scale.
2. All dimensions are in millimeters.
3. Unless otherwise indicated, tolerances are ± 0.1 mm.

Emitter Reel Packaging

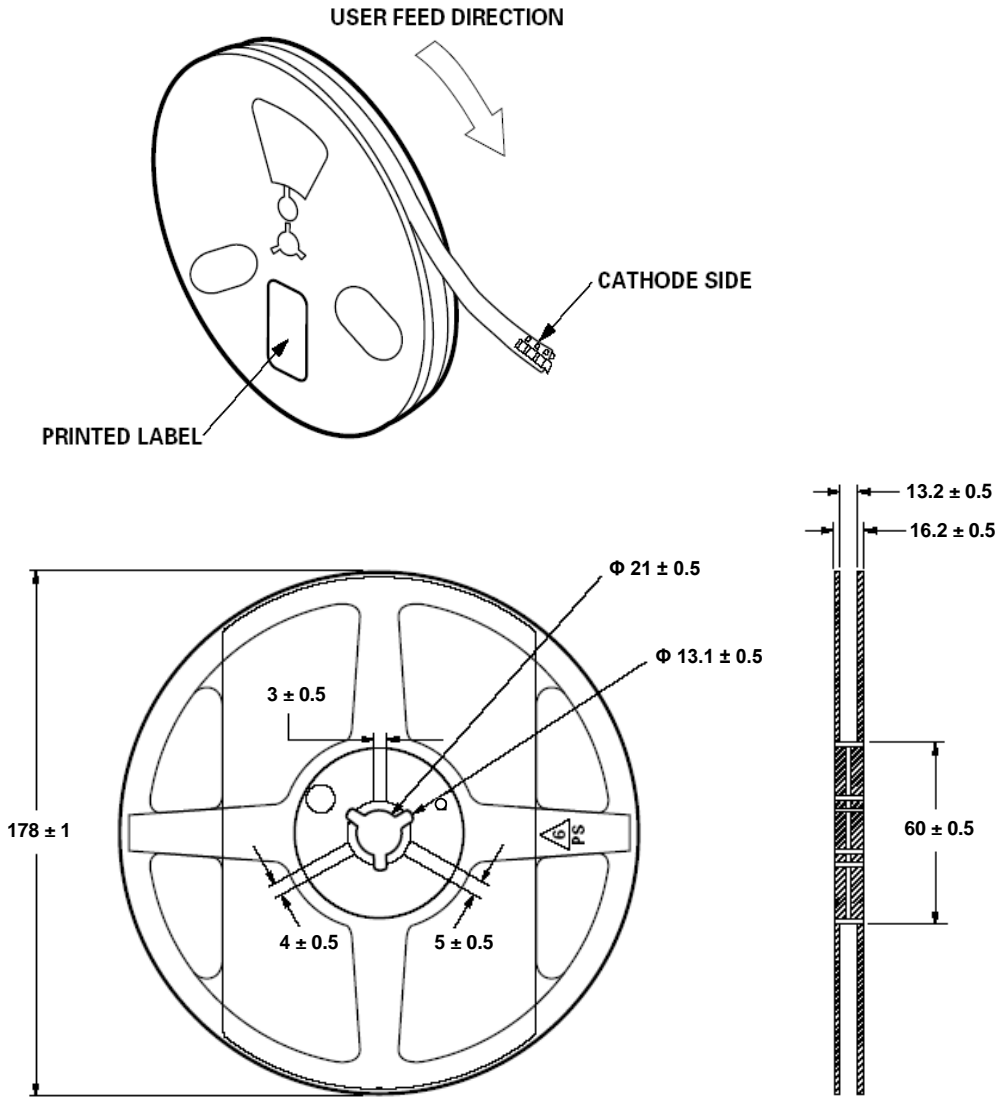

Notes:

1. Empty component pockets sealed with top cover tape.
2. 250 or 500 pieces per reel.
3. Drawing not to scale.
4. All dimensions are in millimeters.

Recommended Soldering Condition

- Please use lead free and “no clean ” solders.
- Soldering shall be implemented using a soldering tip at a temperature lower than 350 °C, and shall be finished within 3.5 seconds for each pad.
- During the soldering process, put the LEDs on materials whose conductivity is poor enough not to radiate heat of soldering.
- Properly solder tin wires before soldering them to LEDs.
- Avoid touching the glass lens with the soldering iron.
- Please prevent flux from touching to the glass lens.
- Please solder evenly on each pad.
- Contacts number of a soldering tip should be within twice for each pad.
- Next process of soldering should be carried out after the LEDs have return to ambient temperature.

*ProLight cannot guarantee if usage exceeds these recommended conditions.

Please use it after sufficient verification is carried out on your own risk if absolutely necessary.

Precaution for Use

- The modules light output are intense enough to cause injury to human eyes if viewed directly. Precautions must be taken to avoid looking directly at the modules with unprotected eyes.
- The modules are sensitive to electrostatic discharge. Appropriate ESD protection measures must be taken when working with the modules. Non-compliance with ESD protection measures may lead to damage or destruction of the product.
- Chemical solvents or cleaning agents must not be used to clean the modules. Mechanical stress on the Emitters must be avoided. It is best to use a soft brush, damp cloth or low-pressure compressed air.
- The products should be stored away from direct light in dry location.
- The appearance, specifications and flux bin of the product may be modified for improvement without notice. Please refer to the below website for the latest datasheets.
<http://www.prolightopto.com/>

Handling of without Cover Lens LEDs

Notes for handling of without cover lens LEDs

- Please do not use a force of over 0.3kgf impact or pressure on the emitting area, otherwise it will cause a catastrophic failure.
- Avoid touching the emitting area especially by sharp tools such as Tweezers.
- Avoid leaving fingerprints on the emitting area .
- Please store the LEDs away from dusty areas or seal the product against dust.
- Please do not mold over the emitting area with another resin. (epoxy, urethane, etc)

